



The MXAN-LN series are high bandwidth intensity modulators specially designed for the transmission of analog signals over optical fibers.

The MXAN-LN's performance parameters meet the requirement of the most demanding analog transmission links for military and civil applications : the x-cut design offers an unmatched stability, the low insertion loss optimizes links gain and the high linearity preserves the signal quality. They are specially suitable for microwave links and remoted antennas.

## FEATURES

- High linearity
- High EO bandwidth 10, 20, 30 GHz
- High stability
- Low insertion loss
- Operation in C and L bands

## APPLICATIONS

- RoF
- Antenna remoting
- Microwave and Radar links
- Space and defence systems

## OPTIONS

- 1300, 1000, 800 nm band versions
- Hermetic sealing

## RELATED EQUIPMENTS

- DR-AN RF amplifiers
- MBC ditherless Bias Controllers
- Turn-key ModBox systems

## MXAN-LN-10 Performance Highlights

Parameter	Min	Typ	Max	Unit
Operating wavelength	1530	-	1580	nm
Insertion loss	-	2.7	-	dB
Electro-optical bandwidth	10	12	-	GHz
$V_{\pi}$ RF @50 kHz	-	5.5	-	V
2nd harmonic suppression ratio	-	70	-	dB
Input 3rd order intercept	-	30	-	dB

Specifications given at 25 °C, 50  $\Omega$ , 1550 nm

## MXAN-LN-20 Performance Highlights

Parameter	Min	Typ	Max	Unit
Operating wavelength	1530	-	1580	nm
Insertion loss	-	2.7	-	dB
Electro-optical bandwidth	18	20	-	GHz
$V_{\pi}$ RF @50 kHz	-	5.5	-	V
2nd harmonic suppression ratio	-	70	-	dB
Input 3rd order intercept	-	30	-	dB

Specifications given at 25 °C, 50  $\Omega$ , 1550 nm

**MXAN-LN-10**  
 10 GHz Analog Intensity Modulator

**Electrical Characteristics** 50 Ω RF input

Parameter	Symbol	Condition	Min	Typ	Max	Unit
Electro-optic bandwidth	$S_{21}$	RF electrodes, from 2 GHz	10	12	-	GHz
Ripple S21	$\Delta S_{21}$	RF electrodes, $f < 10$ GHz	-	0.5	1	dB
Electrical return loss	$ES_{11}$	RF electrodes, $f < 10$ GHz	-	-12	-10	dB
$V_{\pi}$ RF @50 kHz	$V_{\pi RF_{50\text{ kHz}}}$	RF electrodes	-	5.5	6	V
$V_{\pi}$ RF @10 GHz	$V_{\pi RF_{10\text{ GHz}}}$	RF electrodes	-	6.5	7	V
$V_{\pi}$ DC electrodes	$V_{\pi DC}$	DC electrodes	-	6.5	7	V
2 <sup>nd</sup> harmonic suppression ratio	$H_1 - H_2$	Measured @5 GHz	-	70	-	dB
Input 3 <sup>rd</sup> order intercept	IIP3	Measured @5 GHz	28	30	-	dBm
RF input impedance	$Z_{in-RF}$	-	-	40	-	Ω
DC input impedance	$Z_{in-DC}$	-	-	1	-	MΩ

**Optical Characteristics** All specifications given at 25°C, 1550 nm, unless differently specified

Parameter	Symbol	Condition	Min	Typ	Max	Unit
Crystal	-	-	Lithium Niobate X-Cut Y-Prop			
Operating wavelength	$\lambda$	-	1530	1550	1580	nm
Insertion loss	IL	Without connectors	-	4	5	dB
		Option Low IL, without connectors	-	2.7	3	dB
DC extinction ratio	ER	Measured with narrow source linewidth $< 200$ MHz	20	22	-	dB
Optical return loss	ORL	-	-40	-45	-	dB
Chirp	$\alpha$	-	-0.1	0	0.1	-

**Absolute Maximum Ratings**

Stresses in excess of the absolute maximum ratings can cause permanent damage to the device. These are absolute stress ratings only. Functional operation of the device is not implied at these or any other conditions in excess of those given in the operational sections of the data sheet. Exposure to absolute maximum ratings for extended periods can adversely affect device reliability.

Parameter	Symbol	Min	Max	Unit
RF input power	$EP_{in}$	-	28	dBm
Bias voltage	$V_{bias}$	-20	+20	V
Optical input power	$OP_{in}$	-	20	dBm
Operating temperature	OT	0	+70	°C
Storage temperature	ST	-40	+85	°C

**MXAN-LN-20**  
 20 GHz Analog Intensity Modulator

**Electrical Characteristics** 50 Ω RF input

Parameter	Symbol	Condition	Min	Typ	Max	Unit
Electro-optic bandwidth	$S_{21}$	RF electrodes, from 2 GHz	18	20	-	GHz
Ripple S21	$\Delta S_{21}$	RF electrodes, $f < 20$ GHz	-	0.5	1	dB
Electrical return loss	$ES_{11}$	RF electrodes, $f < 20$ GHz	-	-12	-10	dB
$V_{\pi}$ RF @50 kHz	$V_{\pi RF_{50\text{ kHz}}}$	RF electrodes	-	5.5	6	V
$V_{\pi}$ RF @20 GHz	$V_{\pi RF_{20\text{ GHz}}}$	RF electrodes	-	8	8.5	V
$V_{\pi}$ DC electrodes	$V_{\pi DC}$	DC electrodes	-	6.5	7	V
2 <sup>nd</sup> harmonic suppression ratio	$H_1 - H_2$	Measured @5 GHz	-	70	-	dB
Input 3 <sup>rd</sup> order intercept	IIP3	Measured @5 GHz	28	30	-	dBm
RF input impedance	$Z_{in-RF}$	-	-	40	-	Ω
DC input impedance	$Z_{in-DC}$	-	-	1	-	MΩ

**Optical Characteristics** All specifications given at 25°C, 1550 nm, unless differently specified

Parameter	Symbol	Condition	Min	Typ	Max	Unit
Crystal	-	-	Lithium Niobate X-Cut Y-Prop			
Operating wavelength	$\lambda$	-	1530	1550	1580	nm
Insertion loss	IL	Without connectors	-	4	5	dB
		Option Low IL, without connectors	-	2.7	3	dB
DC extinction ratio	ER	Measured with narrow source linewidth $< 200$ MHz	20	22	-	dB
Optical return loss	ORL	-	-40	-45	-	dB
Chirp	$\alpha$	-	-0.1	0	0.1	-

**Absolute Maximum Ratings**

Stresses in excess of the absolute maximum ratings can cause permanent damage to the device. These are absolute stress ratings only. Functional operation of the device is not implied at these or any other conditions in excess of those given in the operational sections of the data sheet. Exposure to absolute maximum ratings for extended periods can adversely affect device reliability.

Parameter	Symbol	Min	Max	Unit
RF input power	$EP_{in}$	-	28	dBm
Bias voltage	$V_{bias}$	-20	+20	V
Optical input power	$OP_{in}$	-	20	dBm
Operating temperature	OT	0	+70	°C
Storage temperature	ST	-40	+85	°C

#### MXAN-LN-10 Typical S21 & S11 Curves

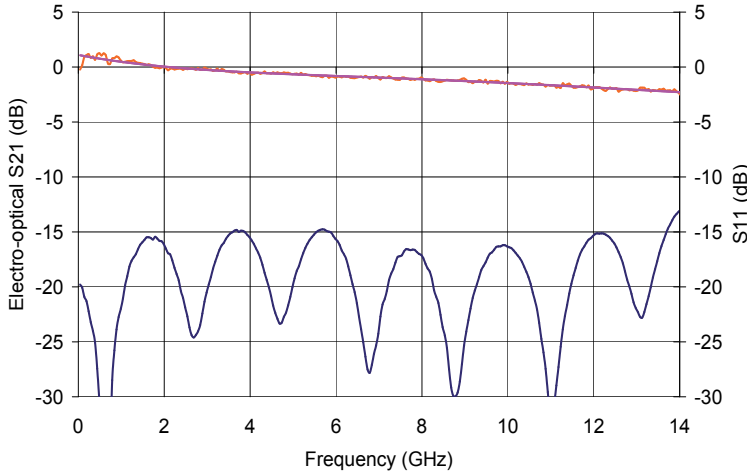

#### MXAN-LN-20 Typical S21 & S11 Curves

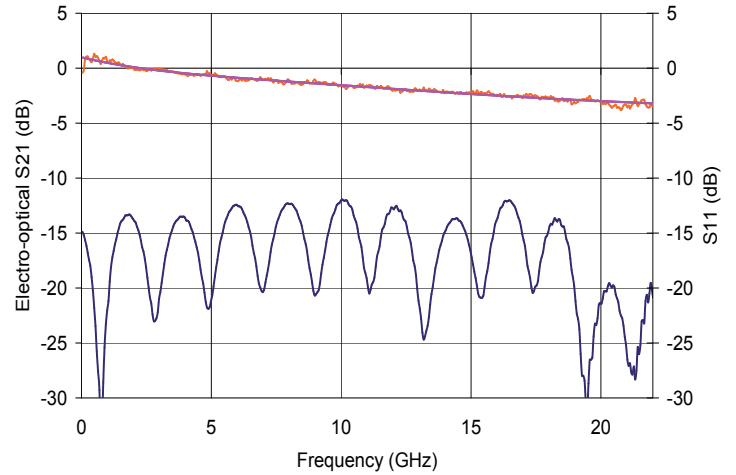

#### Input IP3 Typical curve, @7 GHz

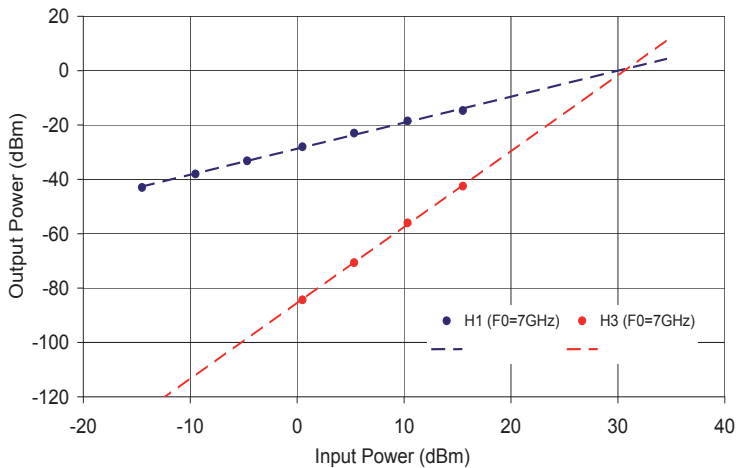

#### Typical compression curve (MX-AN-LN-20)

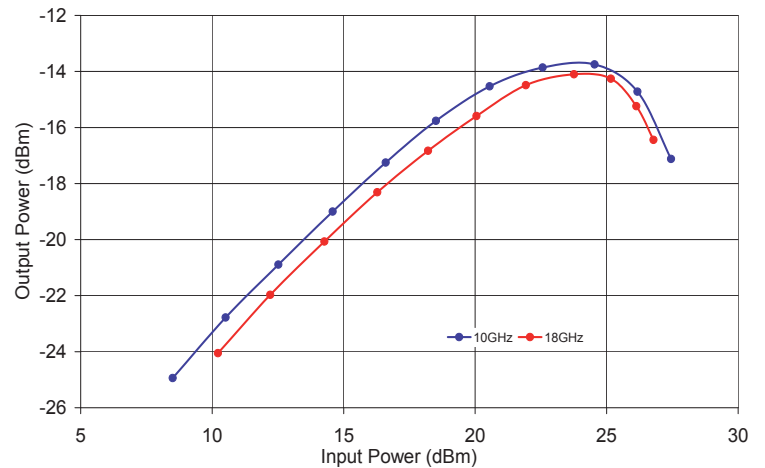

#### Harmonics output, Pin = 0 dBm

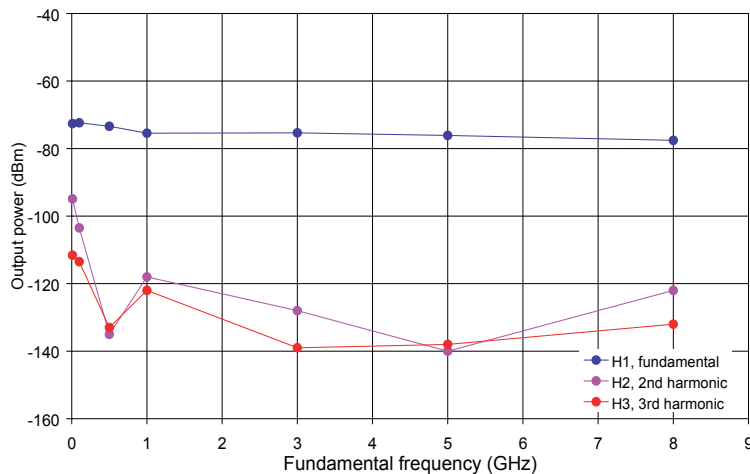

#### Harmonic suppression ratio, Pin = 0 dBm

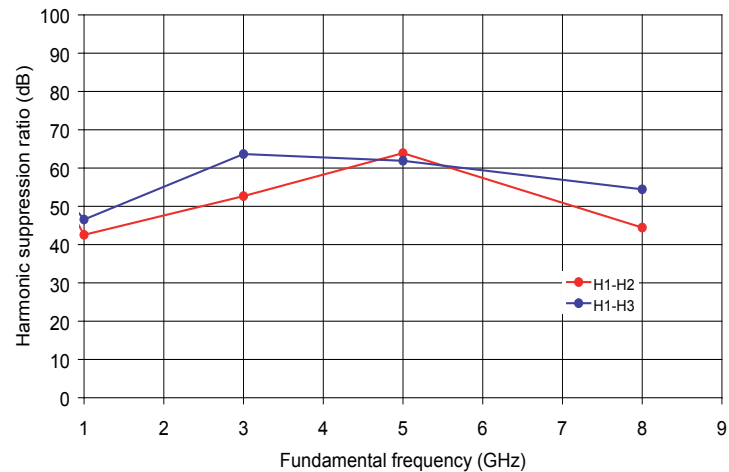

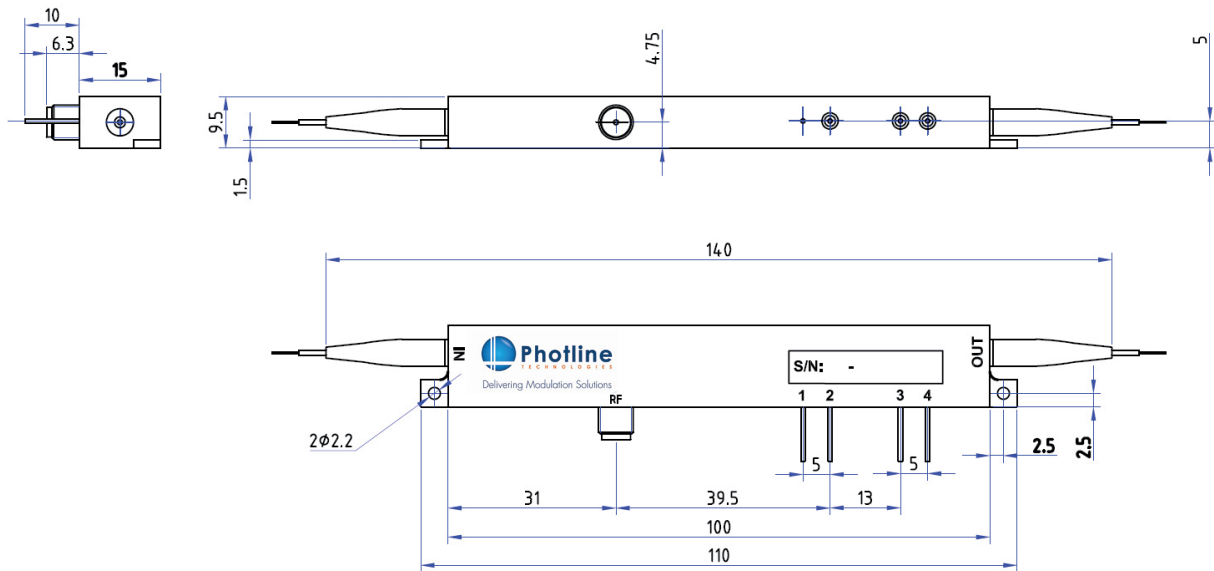
**Mechanical Diagram and pinout** All measurements in mm

Port	Function	Note
IN	Optical input port	Polarization maintaining fiber, Corning PM 98-U25A, Length 1.5 meter. Buffer diameter 900 μm
OUT	Optical output port	Polarization maintaining fiber, Corning PM 98-U25A, Length 1.5 meter. Buffer diameter 900 μm
RF	RF input port	Wiltron female K (SMA compatible)
1	Ground	Pin feed through diameter 1.0 mm
2	DC	Pin feed through diameter 1.0 mm
3	Photodiode cathode	Pin feed through diameter 1.0 mm
4	Photodiode anode	Pin feed through diameter 1.0 mm

**Ordering information**
**MXAN-LN-BW-XX-Y-Z-AB-CD**

BW = Bandwidth : 10 10 GHz 20 20 GHz

XX = Internal photodiode : 00 Not integrated PD PD Integrated

Y = Input fiber : P Polarisation maintaining S Standard single mode

Z = Input fiber : P Polarisation maintaining S Standard single mode

AB = Output connector : 00 bare fiber FA FC/APC FC FC/SPC

CD = Output connector : 00 bare fiber FA FC/APC FC FC/SPC

Note : optical connectors are Seikoh-Giken with narrow key or equivalent

## Related equipments & Examples of application

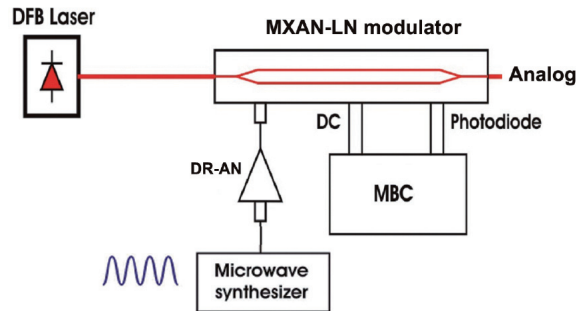

### Analog transmission

The DR-AN is a family of wideband RF amplifier modules designed for analog applications at frequencies up to 36 GHz. They are characterized by a low Noise Figure and a linear transfer function and they match with MXAN-LN type modulator.



The MBC-DG-BT is a bench top automatic bias controller specially designed to lock the operating point of LiNb<sub>3</sub> Mach-Zehnder modulators and ensure a stable operation over time and environmental conditions.



Modbox-AN-Tx and ModBox-AN-Rx are a family of turnkey optical transmitters and receivers for analog applications.

Analog ModBoxes operate and receive from low frequencies up to 40 GHz and from 780 nm up to 1580 nm for high performances transmission.

### About us

Photline Technologies is a provider of Fiber Optics Modulation Solutions based on the company LiNb<sub>3</sub> modulators and high-speed electronics modules. Photline Technologies offers high speed and high data rate modulation solutions for the telecommunication industry and the defense, aerospace, instruments and sensors markets. The products offered by the company include : comprehensive range of intensity and phase modulators (800 nm, 1060 nm, 1300 nm, 1550 nm, 2000 nm), RF drivers and modules, transmitters and modulation units.